

Power-Flite®

Newton Canister Vacuum Operations and Maintenance Manual For Commercial Use Only



PV610-Q10-U

Getting Started

- Introduction 3
- Warranty 3
- Grounding Instructions 4
- Important Safety Instructions 5
- Technical Specifications 7
- Box Contents 8

Template

- Operations 9
- Transport 16
- Storage 16
- Maintenance 16
- Recommended Spares & Accessories 17
- Fault Diagnosis 18

INTRODUCTION



Warranty

Within 30 days of purchase, to activate product warranty, go to: <https://www.powr-flite.com/warranty-registration>



Warning Labels

Prior to operating the Portable Battery Powered Mister, read and understand completely this owner's manual paying special attention to warning labels. These labels indicate a potentially hazardous situation that could result in death or serious injury if not avoided. Use only as described in this manual.



Important

There are no owner serviceable parts inside this machine. Removal of screws and accessing internal components will void all warranty claims.

Your new Powr-Flite unit is a high quality, precision-made product. All parts used in the manufacturing of this unit have passed rigid quality control standards prior to assembly. Please safeguard the original receipt/invoice given at the time of purchase. If you experience any problems with your unit during the warranty period, the original receipt/invoice will act as proof of purchase.

Upon receipt, inspect outer box for exterior damage. Unpack all internal parts, ensure all items are present according to the owner's manual, and review components for damage.

Each unit is tested and thoroughly inspected prior to shipping. If damage is discovered, immediately notify the transportation company that delivered your machine and request an inspection. As a manufacturer, we are unable to act upon any claim for concealed damage and you must originate the claim. Be sure to keep the carton, packing inserts, and carrier's receipt until the inspector has verified your claim.

GROUNDING INSTRUCTIONS

DANGER: Improper use of the grounding plug can result in a risk of electric shock.

WARNING!

Improper connection of the equipment-grounding conductor can result in a risk of electric shock. Check with a qualified electrician or service person if you are in doubt as to whether the outlet is properly grounded. DO NOT modify the plug provided with the appliance. If it will not fit the outlet, have a proper outlet installed by a qualified electrician.

GROUNDING METHODS

This appliance must be grounded. If it should malfunction or breakdown, grounding provides a path of least resistance for electric current to reduce the risk electric shock. This machine is equipped with a cord having an equipment-grounding conductor and grounding plug. The plug must be inserted into an appropriate outlet that is properly installed and grounded in accordance with all local codes and ordinances.

This appliance is for use on a nominal 115-volt circuit, and has a grounding plug that looks like the plug illustrated in sketch A.

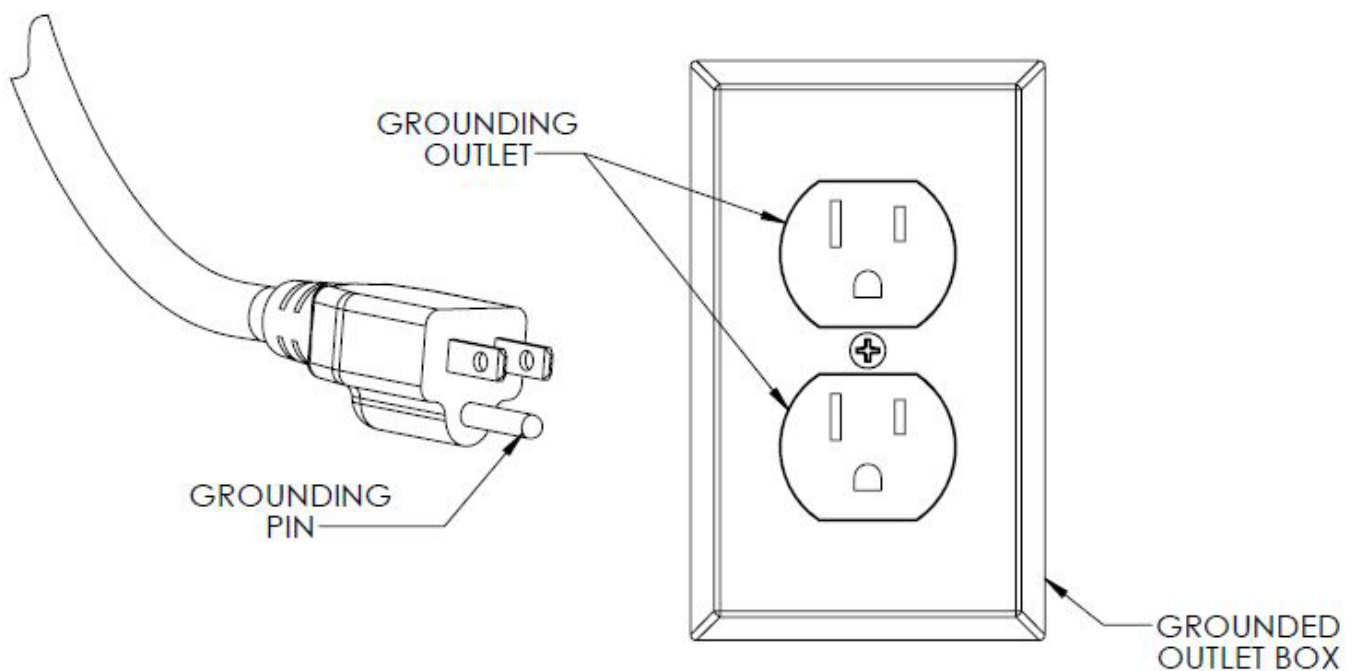

A

IMPORTANT SAFETY INSTRUCTIONS

READ AND UNDERSTAND ALL INSTRUCTIONS BEFORE USING THIS UNIT

Read and understand this owner's manual and all labels on the unit before operating. Safety is a combination of common sense, staying alert, and knowing how your unit works. Use this unit only as described in this manual. Use only manufacturer's recommended attachments. To reduce the risk of personal injury or damage to your unit use only recommended accessories.

WARNING To avoid fire, DO NOT use with a flammable or combustible liquid or floor cleaner.

WARNING To avoid electric shock, DO NOT expose to rain. Store Indoors.

When using this unit, basic precautions should always be followed, including the following:

- DO NOT leave unit when plugged in. Unplug from outlet when not in use and before servicing.
- DO NOT allow unit to be used as a toy. Close attention is necessary when used around or near children.
- Use only as described in this manual. Use only manufacturer's recommended attachments.
- DO NOT use with damaged cord or plug. If unit is not working properly because it has been dropped, dropped into water, left outdoors, or damaged in any way, contact a service center
- DO NOT handle plug or appliance with wet hands.
- DO NOT put any objects into openings.
- DO NOT use with any opening blocked: keep free of dust, lint, hair, or anything that may reduce air flow.
- Keep hair, loose clothing, fingers, and all parts of body away from openings and moving parts.
- DO NOT pick up anything that is smoking or burning such as cigarettes, matches, or hot ashes.
- DO NOT use to pick up hazardous chemicals.
- Turn off all controls before unplugging.
- Turn unit off immediately if foam or liquid comes from machine exhaust. Empty & clean out recovery (dirty) tank and use defoamer to correct the problem.
- DO NOT use to pick up flammable or combustible liquids such as gasoline or use in areas where they may be present.
- DO NOT use where oxygen or anesthetics are used.
- Replace damaged or worn parts immediately with genuine original equipment parts to maintain safety.
- This unit must be connected to a properly grounded outlet only. See grounding instructions.
- DO NOT use equipment out of doors or in the rain.
- DO NOT use equipment near or around flammable or explosive materials, fuels, or solvents.
- DO NOT allow the unit to freeze.
- Anyone designated to operate this equipment must, without fail, read and thoroughly understand all instructions and precautions prior to use.
- Never lift the machine by pressure regulator (on heated model).
- Wear safety equipment and clothing to protect from extremely hot water.
- Do not operate in standing water.
- Do not operate equipment under any unsafe condition.

SAVE THESE INSTRUCTIONS

IMPORTANT SAFETY INSTRUCTIONS



State of California Proposition 65 Warnings

WARNING: This product contains one or more chemicals known to the state of California to cause cancer.

WARNING: This product contains one or more chemicals known to the state of California to cause birth defects or other reproductive harm.



Intended Use

Do NOT modify this unit in any way or adapt it for any other use. Modification of this unit in any way will void all warranties and could create safety hazards.

SPECIFICATIONS

Model		
Product Code	PV610-Q10-U	
Voltage AC (~)/ Frequency	V/Hz	115/60
Construction Class		II
Vacuum Motor Power	W	1200
Filtration	3-stage (w/ H13 Filter Bag)	
Airflow Rate	l/s/cfm	30.5/65
Water lift	mm/inches	2529/100
Capacity	litres/gallons	10/2.6
Productivity Rate	m ² /h/sq.ft./hr	232/2497
Sound pressure level	dB(A)	65
Sound power level	dB(A)	72
Dimensions (L x W x H)	mm/inches	364 x 240 x 200/14.3 x 19.5 x 7.9
Weight	kg/lbs.	6/13
Wand length	mm/inches	576/956/22.5/37.5
Hose length	m/inches	2/78
Cable length	m/ft	10.6/35
Ingress Protection Rating		IP20

- Above dimensions are approx. Since the company's policy is to continuously improve the product, there could be changes without prior notice.
- Noise levels measured at a distance of 1 meter from machine and 1.6 meters above floor, when operating on a hard floor. Measurements recorded using a hand held meter.
- Handle vibration does not exceed 2.5 m/s² when operating on a smooth floor surface.



BOX CONTENTS

Upon initial receipt of unit, open box and ensure all parts are included as shown below.

NEED PICTURE(S) OF BOX CONTENTS

OPERATING INSTRUCTIONS

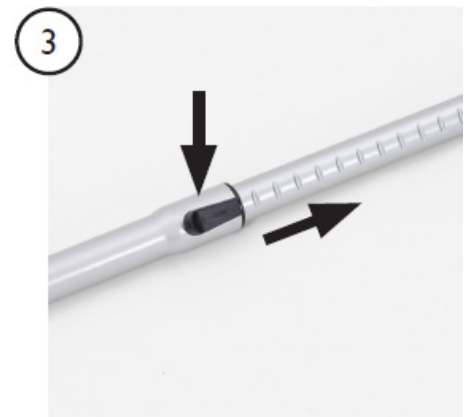
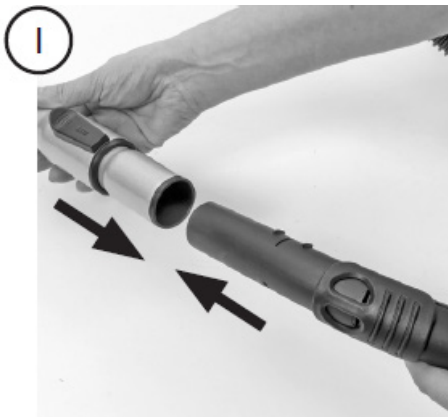
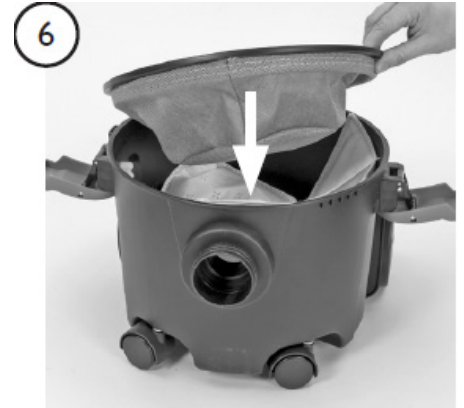
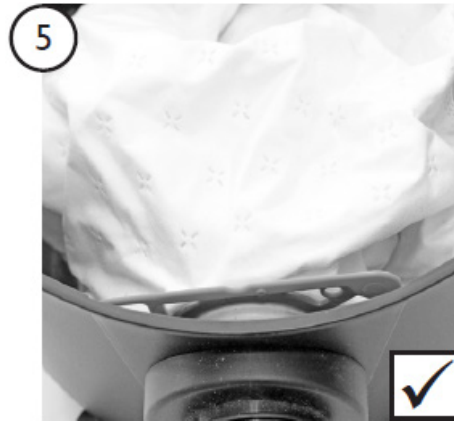
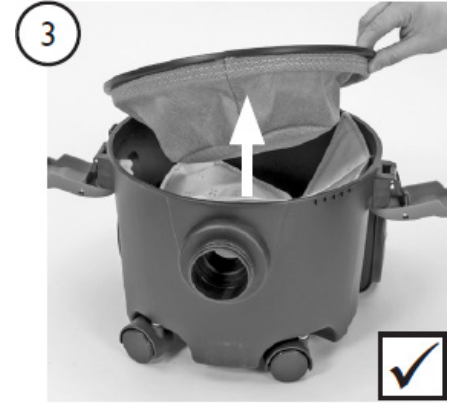
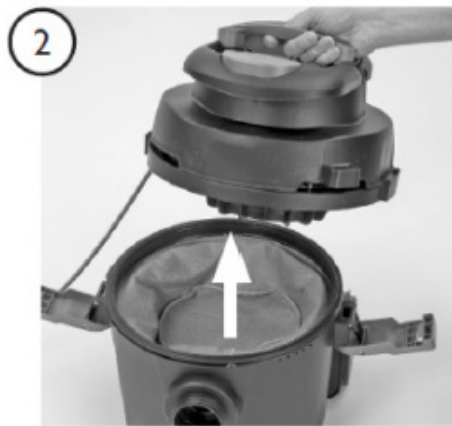
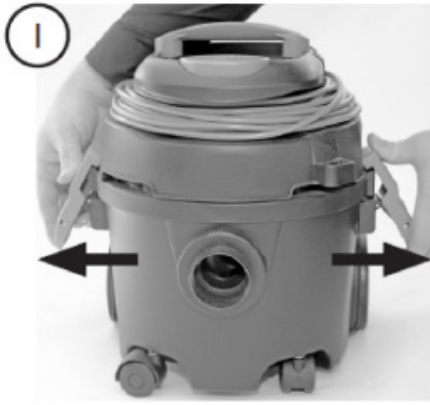

OPERATING INSTRUCTIONS

4

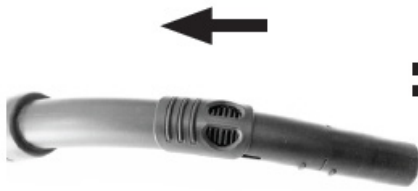

=

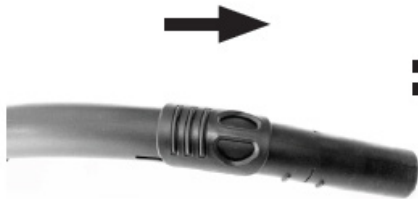
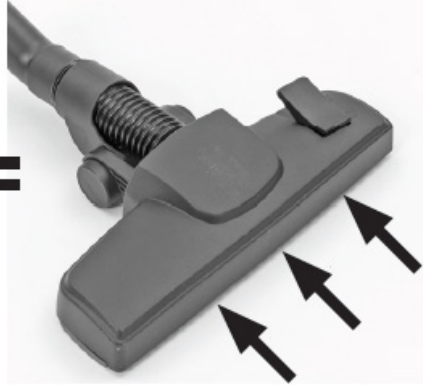

=

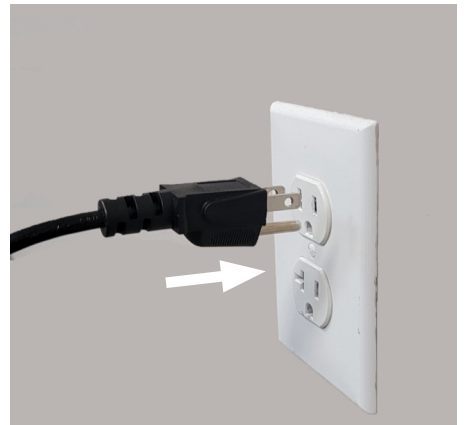
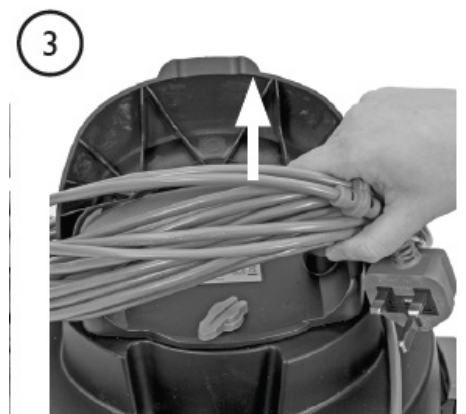
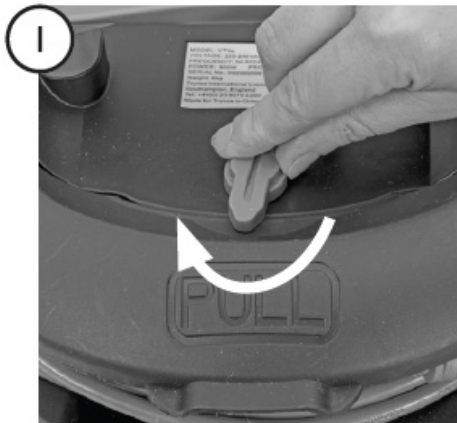
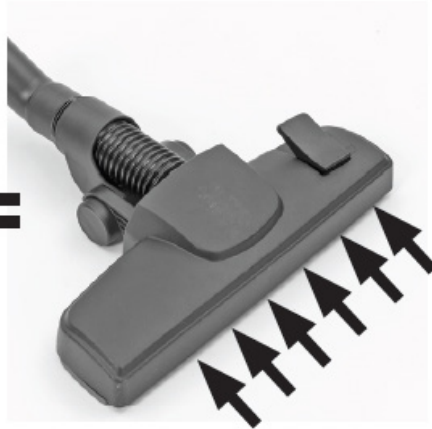

OPERATING INSTRUCTIONS

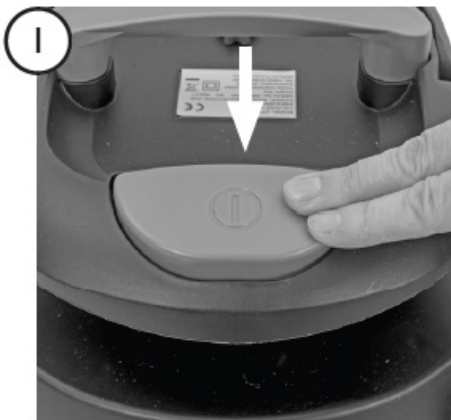
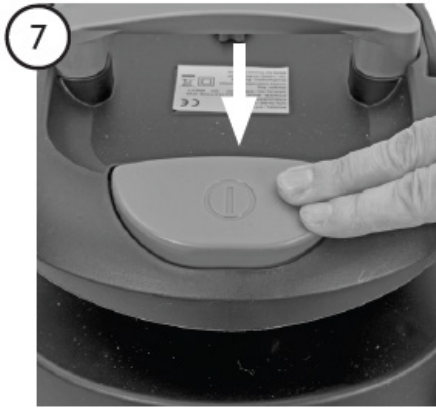

OPERATING INSTRUCTIONS

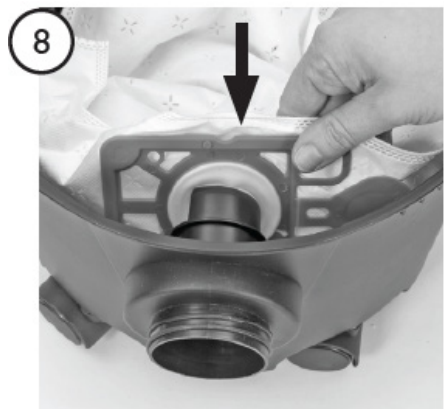
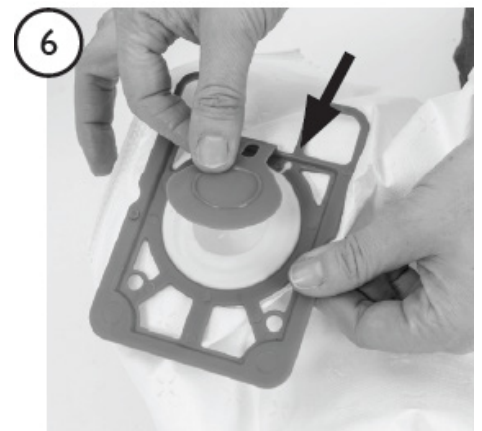
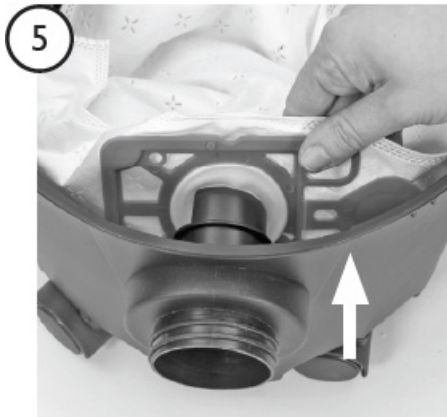
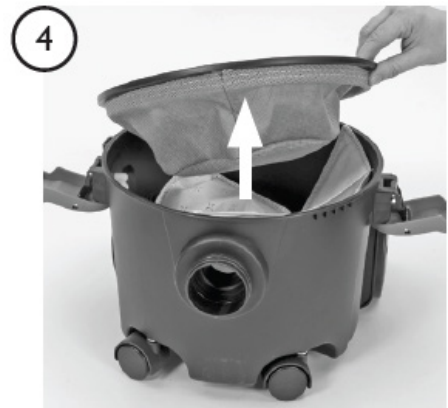
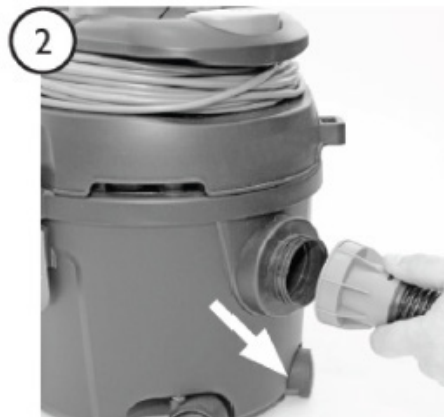

OPERATING INSTRUCTIONS

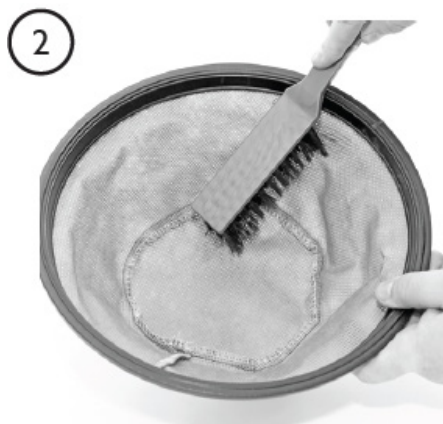

4

2021																								
January		February		March																				
Sun	Mon	Tue	Wed	Thu	Fri	Sat	Sun	Mon	Tue	Wed	Thu	Fri	Sat	Sun	Mon	Tue	Wed	Thu	Fri	Sat				
					1	2	1	2	3	4	5	6	7	8	9	10	11	12	13					
3	4	5	6	7	8	9	7	8	9	10	11	12	13	14	15	16	17	18	19	20				
10	11	12	13	14	15	16	14	15	16	17	18	19	20	21	22	23	24	25	26	27				
17	18	19	20	21	22	23	21	22	23	24	25	26	27	28	29	30	31							
24	25	26	27	28	29	30	28	29	30	31														
31																								

April		May		June																				
Sun	Mon	Tue	Wed	Thu	Fri	Sat	Sun	Mon	Tue	Wed	Thu	Fri	Sat	Sun	Mon	Tue	Wed	Thu	Fri	Sat				
							1	2	3				1	2	3	4	5							
4	5	6	7	8	9	10	2	3	4	5	6	7	8	6	7	8	9	10	11	12				
11	12	13	14	15	16	17	9	10	11	12	13	14	15	13	14	15	16	17	18	19				
18	19	20	21	22	23	24	16	17	18	19	20	21	22	20	21	22	23	24	25	26				
25	26	27	28	29	30	23	24	25	26	27	28	29	27	28	29	30								
							30	31																

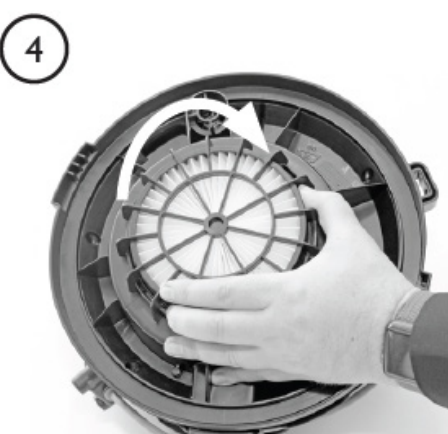
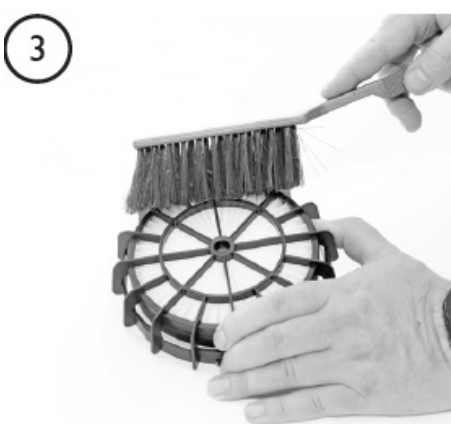
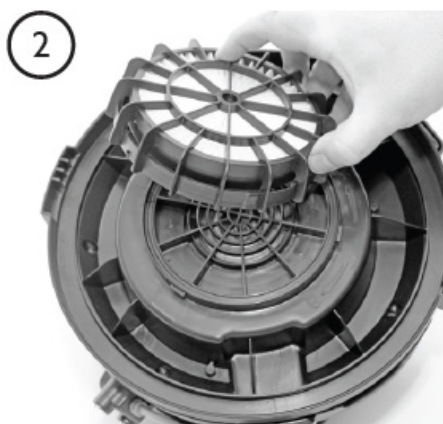
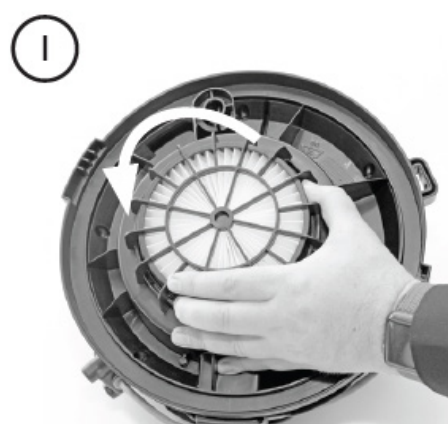

5

2021																								
January		February		March																				
Sun	Mon	Tue	Wed	Thu	Fri	Sat	Sun	Mon	Tue	Wed	Thu	Fri	Sat	Sun	Mon	Tue	Wed	Thu	Fri	Sat				
					1	2	1	2	3	4	5	6	7	8	9	10	11	12	13					
3	4	5	6	7	8	9	7	8	9	10	11	12	13	14	15	16	17	18	19	20				
10	11	12	13	14	15	16	14	15	16	17	18	19	20	21	22	23	24	25	26	27				
17	18	19	20	21	22	23	21	22	23	24	25	26	27	28	29	30	31							
24	25	26	27	28	29	30	28	29	30	31														
31																								

April		May		June																				
Sun	Mon	Tue	Wed	Thu	Fri	Sat	Sun	Mon	Tue	Wed	Thu	Fri	Sat	Sun	Mon	Tue	Wed	Thu	Fri	Sat				
							1	2	3				1	2	3	4	5							
4	5	6	7	8	9	10	2	3	4	5	6	7	8	6	7	8	9	10	11	12				
11	12	13	14	15	16	17	9	10	11	12	13	14	15	13	14	15	16	17	18	19				
18	19	20	21	22	23	24	16	17	18	19	20	21	22	20	21	22	23	24	25	26				
25	26	27	28	29	30	23	24	25	26	27	28	29	27	28	29	30								
							30	31																

OPERATING INSTRUCTIONS

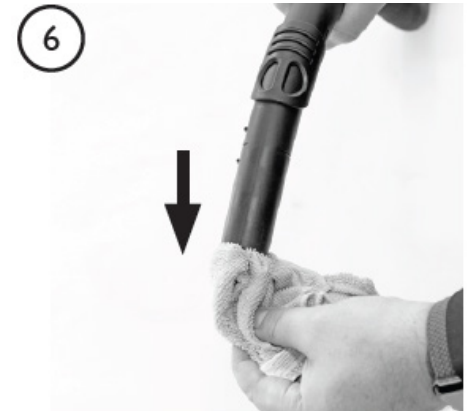
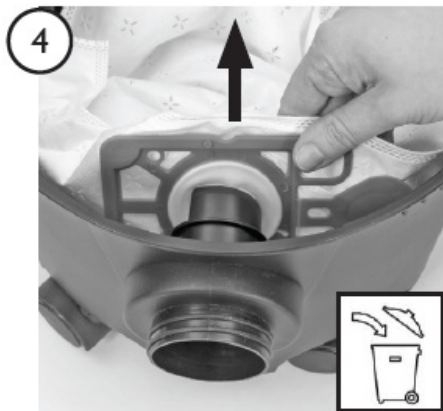
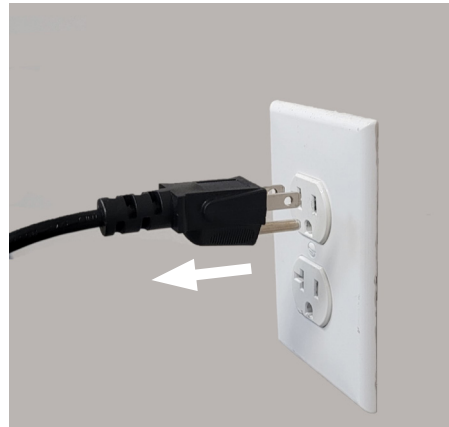
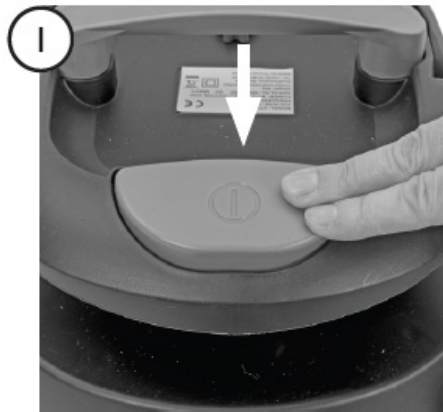
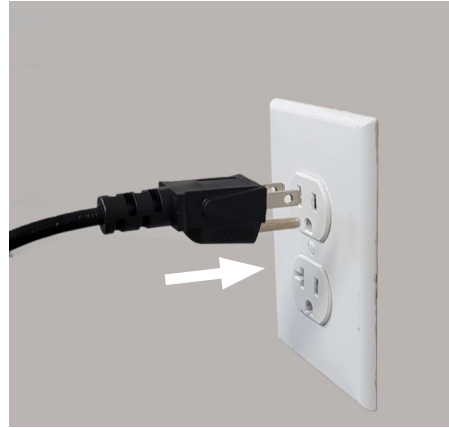

OPERATING INSTRUCTIONS

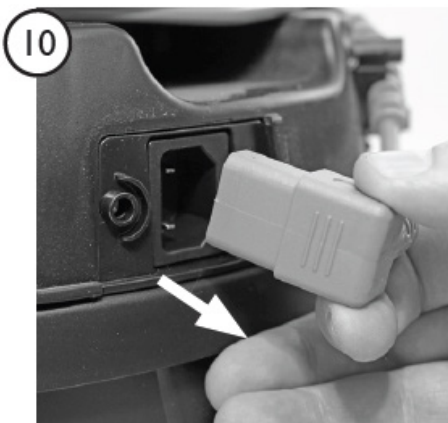
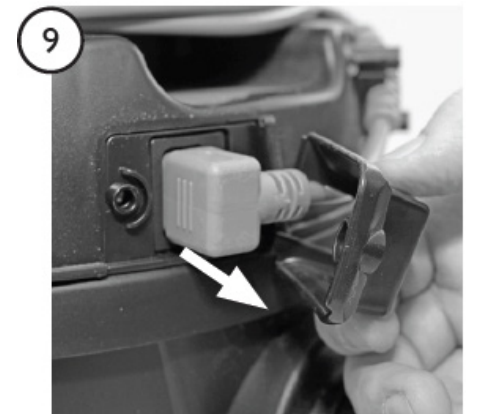
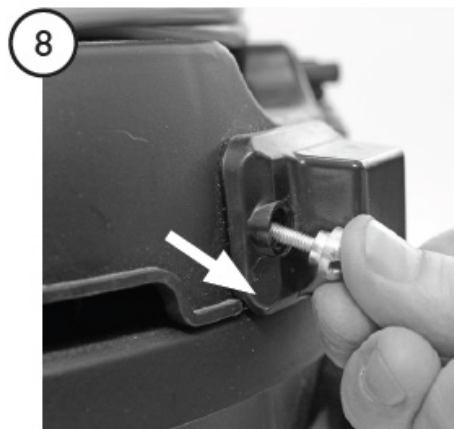
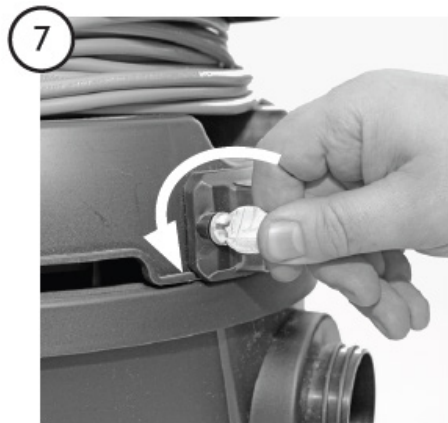
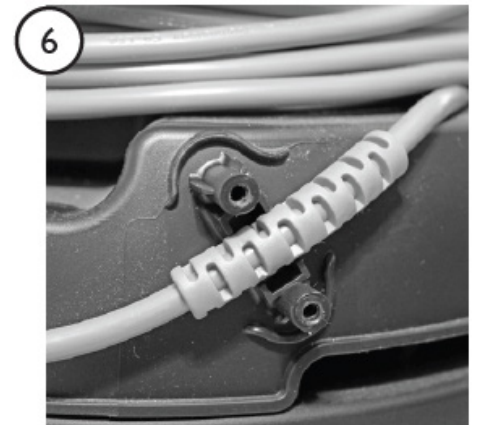
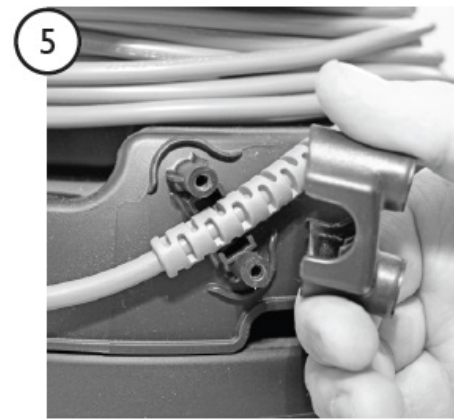
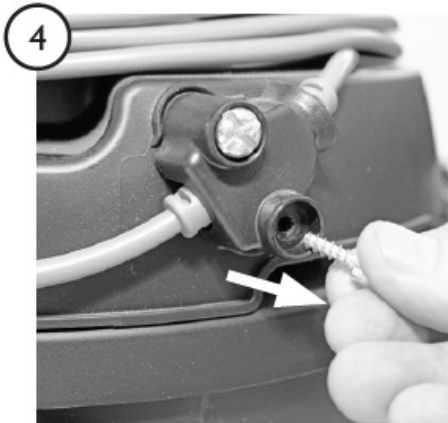
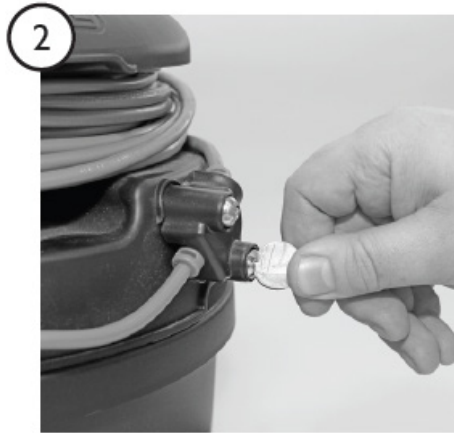
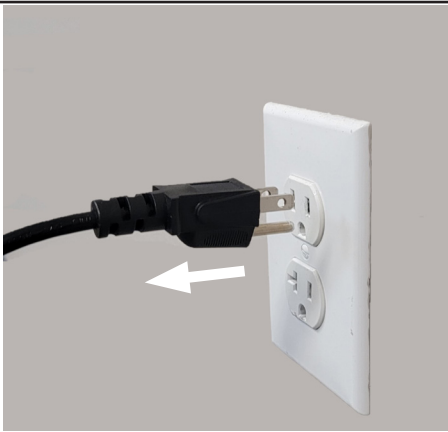

TRANSPORTING THE MACHINE

- Take extreme care when moving the machine up or down steps or stairs.
- Incorrect lifting techniques may result in personal injury. We advise that the manual handling regulations are followed. Carefully wrap the power cord and store in dry indoor location.
- DO NOT expose the machine to rain or moisture.
- When transporting the machine ensure that all components, tanks and removable parts are securely fastened, and that the power cord and plug are not trailing.

STORAGE

- Always switch off the machine after use.
- Store the machine in a dry indoor area only.
- Wrap the power cord around the cable winder ensuring that the plug is not trailing on the floor.
- Always switch off, empty, wipe down and dry the machine after use.

MAINTENANCE

 **WARNING** - Before undertaking maintenance operations or adjustments switch off machine and unplug from the electrical supply.

IMPORTANT – All other servicing and repairs should only be performed by an Authorized Service Agent.

IMPORTANT – Should the machine fail to operate please refer to the fault diagnosis section in the back of this instruction manual. If the problem / remedy is not listed, please contact Customer Service Department.

The machine requires minimum maintenance apart from the following checks by the operator prior to use:

- Body of the machine - Clean with a damp cloth.
- Power cord - Regularly inspect sheath, plug and cord ends for damage or loose connection.
- Air vents - Check for dust accumulation around the air inlet and outlet vents of the motor cooling-air system and clean if necessary. Blocked vents will cause the motor to overheat and may lead to premature failure. Warranty claims for this type of damage will not be accepted.
- Vacuum filter – Check that the vacuum filter is clean and replace as appropriate.
- Hose, wand and vacuum accessories – Check and remove any debris or lint build-up from the head.

RECOMMENDED SPARES & ACCESSORIES

Item	Part No.
F9 Rinseable Filter	X6101
25 Pack HEPA Filter Bags	X6100
Hose	X6102
Telescopic wand	X6103
Floor tool	X6104
Dusting Brush and Crevice Tool	X6105
Basket Filter	X6107

FAULT DIAGNOSIS

The following simple checks may be performed by the operator. If the machine is still not working, please contact your local Service Agent:

Trouble	Reason	Remedy
Machine is not working	Lack of voltage/electrical supply	Check fuse *, power cord, plug and socket outlet
Loss of vacuum suction	Dust bag full. Blocked hose or wand. Motor is not running.	Replace bag. Remove obstruction. Contact Service Agent
Motor is not running	Broken switch. Defective power cord. Defective motor.	Contact Service Agent.

* If the fuse blows several times, the machine should be checked by an authorized Service Agent

Powr-Flite®

Powr-Flite
3101 Wichita Court
Ft. Worth, TX 76140-1755
Phone: 817-551-0700
WWW.POWR-FLITE.COM

Record of Purchase



Serial Number: _____
Purchase Date: _____
Dealer: _____
Phone Number: _____